

Viking Use & Care Manual

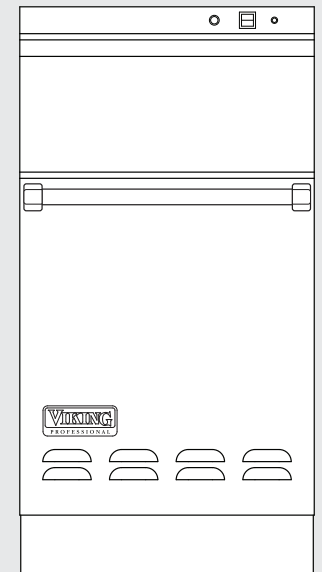

Viking Range Corporation
111 Front Street
Greenwood, Mississippi 38930 USA
(662) 455-1200

For product information,
call 1-888-VIKING1 (845-4641)
or visit the Viking Web site at
vikingrange.com



Professional Series
Undercounter Trash Compactor

Congratulations

Your purchase of this product attests to the importance you place upon the quality and performance of the major appliances you choose. With minimal care, as outlined in this manual, this product is designed to provide you with years of dependable service. Please take the few minutes necessary to learn the proper and efficient use and care of this quality product.

We appreciate your choosing a Viking Range Corporation product, and hope that you will again select our products for your other major appliance needs.

Table of Contents

| | |
|--------------------------------------------|----|
| Important Safety Instructions | 2 |
| Compactor Features | 4 |
| Loading Your Compactor | 5 |
| Use of Break-Away Trash Basket Without Bag | 6 |
| Use of Break-Away Trash Basket With Bag | 7 |
| Bag Removal | 8 |
| Operating Your Trash Compactor | 9 |
| Charcoal Air Filter With Fan | 11 |
| Special Use Tips | 12 |
| Caring for Your Compactor | 13 |
| Service Information | 15 |
| Warranty | 16 |

IMPORTANT SAFETY INSTRUCTIONS

1. Read all instructions.
2. This compactor must be properly connected to electricity.
3. Use the compactor only for its intended use.
4. **Do Not** allow to be used as a toy, or to run unattended at any time. Close supervision is necessary when used by or near children. Lock when not in use and store key out of reach of children.
5. **Do not** operate with a damaged cord, plug, motor, or after compactor has been damaged in any manner. Have the compactor examined, repaired, or adjusted by an authorized servicer.
6. **Do not** take compactor apart. Incorrect reassembly can cause electrical shock when next used.
7. **Do not** touch moving parts.
8. **Do not** overload compactor. **Do not** overload trash with heavy material such as glass.
9. **Always** place glass bottles, etc., on their sides in the center of the drawer so the wastepaper below and beside the bottle can help keep broken glass near the center of the bag, away from the sides.
10. **Do not** compact any container or material which might contain poisonous or explosive products.
11. **Do not** compact cloths or cans containing paint liquids, thinners, etc., which could create a hazard.
12. Do not shove items down into the compactor with hands or feet. To avoid being cut, let the compactor do the compacting.
13. **Do not** lift a trash bag by the sides. Sharp objects can pierce the bag and cause injury. Always carry a filled trash bag by the top.
14. **Always** wipe off any broken glass before touching the ram cover.
15. **Do not** use the compactor as a counter for electrical cooking appliances nor as a cutting board.
16. **Do not** set hot pans, etc., on the compactor top.
17. **Do not** compact toxic or volatile flammable material such as oily rags and insect sprays. **Do not** compact lighted cigarettes, cigars or other hot or burning items.
18. **Do not** spill any liquids on the compactor top.
19. **Do not** use accessories other than those recommended by the manufacturer.

SAVE THESE INSTRUCTIONS

FOR YOUR SAFETY
DO NOT STORE OR USE GASOLINE OR OTHER
FLAMMABLE VAPORS AND LIQUIDS IN THE VICINITY
OF THIS OR ANY OTHER APPLIANCE. THE FUMES
CAN CREATE A FIRE HAZARD OR EXPLOSION.

WARNING
To reduce the risk of fire, electrical shock, or injury
when using your compactor, follow basic
precautions, including the following safety
instructions

Compactor Features

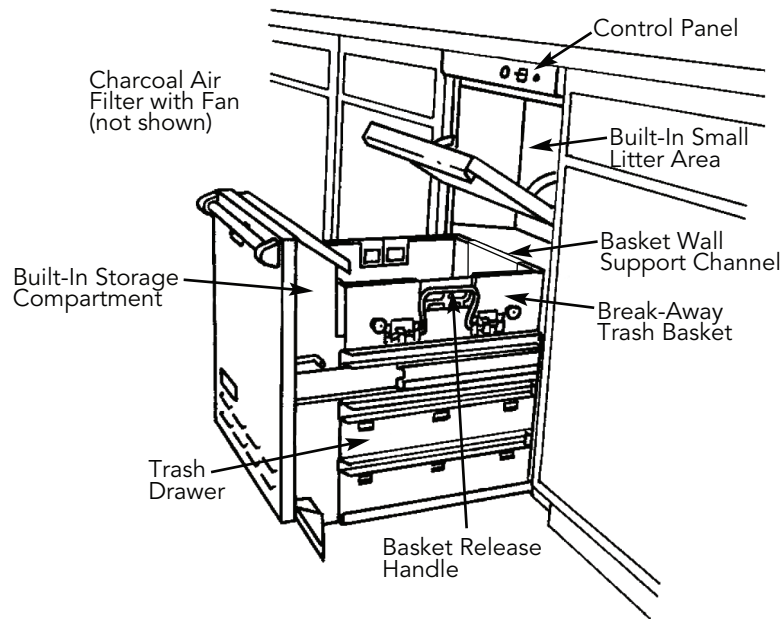

Your compactor has a built-in interlock and will not operate unless you have:

1. Closed the trash drawer.
2. Turned the key to start.

STOP/LOCK will stop the ram movement at any point. After stopping the unit, turn the key to START and ram will return to original "up" position.

WARNING: Do not allow children to operate the compactor. We recommend that you remove the key when not in use. The unit will not operate without it. The trash drawer cannot be locked. Therefore, before running a compactor cycle, always check to be sure that no item has been mistakenly placed in the trash drawer.

Loading Your Compactor

Built-in Small Litter Area

Small cans, paper scraps, small boxes and containers may simply be dropped into the door, rather than opening the large trash drawer. Trash will drop automatically into the large trash drawer when pulled open.

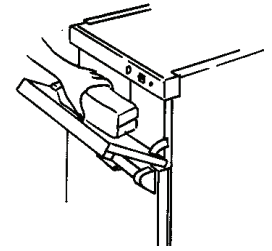

Large Capacity Trash Drawer

Large, bulky items should be placed directly into the drawer. It is not necessary to run a compaction cycle everytime you place trash into the drawer. However, the more you run a cycle, the more compact the trash will be.

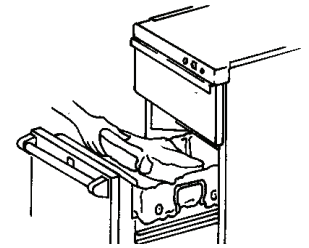

Break-Away Trash Basket

Your trash compactor is equipped with a versatile two-piece, polypropylene basket. It is designed for easy use and removal of compacted trash. The break-away basket may be used with or without the enclosed complimentary supply of trash bags.

NOTE: Basket wall support channels must be in place prior to operating compactor.

Basket Wall Support Channels

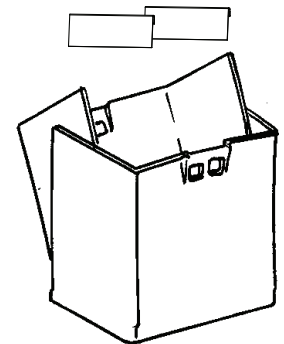

Use of Break-Away Trash Basket Without Bag

1. Place basket release handle in upright position.

2. Put trash directly into the basket. We recommend placing several thicknesses of newspaper at the bottom of the basket when bags are not used. This will minimize clean-up of the basket after emptying compacted trash.

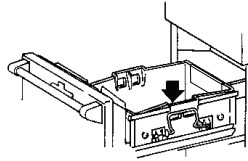

NOTE: Compacting a folded newspaper on top of loose trash will keep the ram clean of trash or broken glass.

To Remove Break-Away Trash Basket

We recommend removing the basket when trash is compacted to four or five inches below the top of the basket. If you find this too heavy, compact less trash next time. **REMEMBER** - the weight of the compacted trash will vary with the contents. Cans and bottles may weigh more than paper products.

1. Place basket release handle in down position. Lift built-in storage compartment cover up.

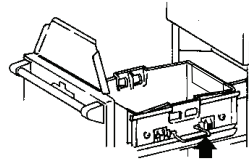

2. Grasp both handles of basket and remove from drawer. Carry basket to trash storage area.

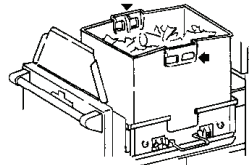

3. Remove basket wall support channels.

4. Pull handles of basket away from each other.

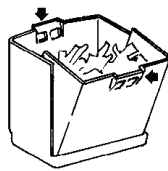

5. Dump compacted trash from half basket into waste receptacle.

6. Replace support channels after dumping.

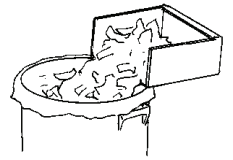

WARNING: PERSONAL INJURY HAZARD

Compacted trash may contain broken glass, metal cans and other sharp objects. Always use the half basket to dump trash. **DO NOT USE BARE HANDS.**

Use of Break-Away Trash Basket With Bag

1. Lift built-in storage compartment cover.

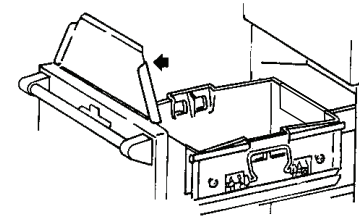

2. Pull basket release handle down.

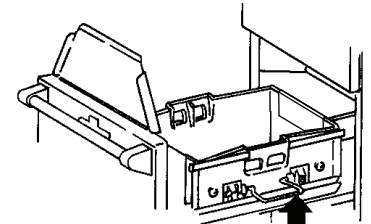

3. Place folded bag inside Break-Away trash basket.

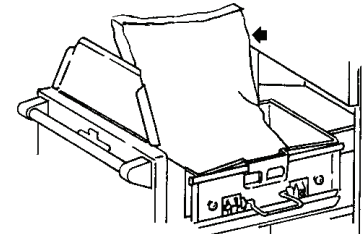

4. Open bag. Pull top edges of bag over top of drawer.

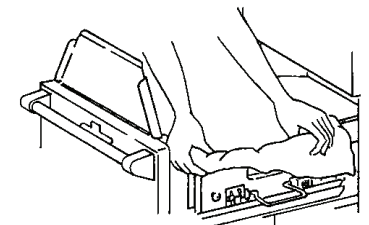

- Lock bag in place by pulling four pre-punched holes over buttons on drawer sides. Holes will expand over buttons without damaging bag.

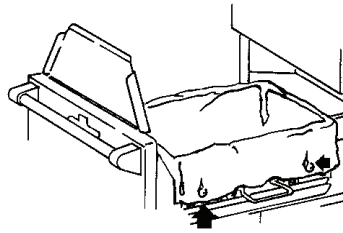

- Spread bag to fit interior of basket. Closing storage compartment cover. Pull basket release handle up.

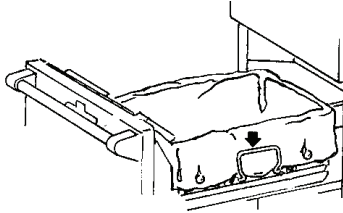

Bag Removal

We recommend removing bag when trash is compacted to four or five inches below top of basket. If you find this is too heavy, compact less trash next time.

- Pull basket release handle down.

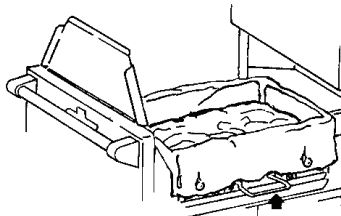

- Lift storage compartment cover up. Release bag from buttons. Pull up top edges of bag.

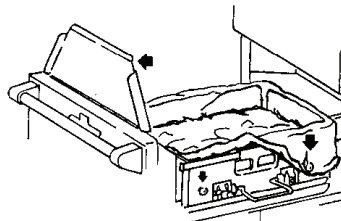

- Close bag with twist-ties provided.

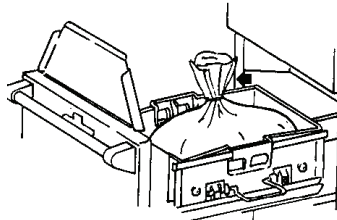

- Grasp handles and remove from drawer. Carry basket with bag to trash storage area.

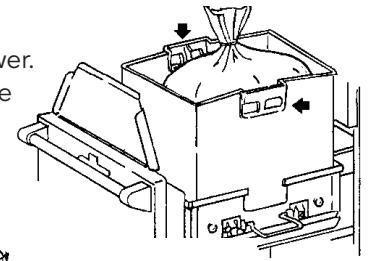

- Pull handles of basket away from each other to loosen bag.

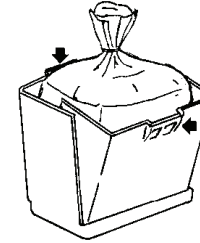

- Lift bag out.

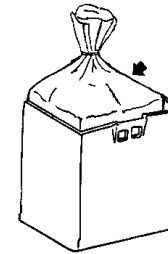

WARNING: PERSONAL INJURY HAZARD

Sharp objects may protrude through bag after removal from trash basket. Handle carefully by the top to avoid injury.

Operating Your Trash Compactor

To Start:

- Close large trash drawer.

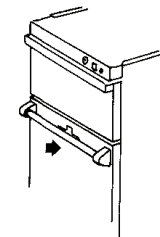

- Turn key to START position and HOLD momentarily. Release key.

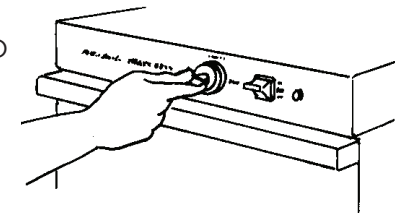

Compaction Cycle

The compactor ram will move down inside the trash drawer, reverse, and return to original position, completing the cycle in approximately 35 seconds. As the basket is filled, the ram travels a shorter distance and cycle time decreases.

DURING THE COMPACTION CYCLE, THE RAM DOES NOT TOUCH THE BOTTOM OF THE DRAWER. THEREFORE, YOU CAN EXPECT TO CYCLE SEVERAL LOOSE TRASH LOADS BEFORE COMPACTION IS EVIDENT. THIS IS NORMAL AND NOT A CAUSE FOR CONCERN.

As the ram compacts difficult to break items, you may notice a downward movement of the compactor drawer. This is normal and will not cause damage. The spring-loaded drawer is specially designed to move down freely and return to original position. The force of the ram during a compaction cycle is absorbed by the heavy gauge steel frame of the compactor.

To Stop Cycle and Open Drawer

You may stop or interrupt a compaction cycle at any time and raise the ram to its original position.

1. Turn the key to STOP/LOCK position to stop the ram.
2. Turn the key to START position and HOLD momentarily to return the ram to original position. The drawer may then be opened.
3. Turn key to START position and HOLD to start another cycle.

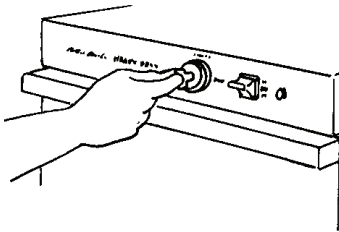

Charcoal Air Filter with Fan

Your trash compactor features an activated charcoal air filter and fan which absorbs and minimizes odor. The charcoal filter is located in the left rear section of the compactor.

The degree of odor in your compactor will depend upon the type of trash you place in it. Since odors are absorbed into the pores of the charcoal filter, it may need to be replaced once or twice a year. Length of time before filter replacement is necessary varies with the types of trash compacted.

Charcoal Air Filter Fan

- ON** - The fan creates fast air movement for greater odor removal. While the fan is on, a fan "on" light will glow on the control panel.
- OFF** - Even when the fan isn't running, the filter is working to remove odor.

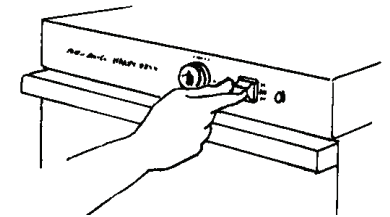

To Remove Filter:

1. With trash drawer in open position, reach into left rear corner where filter is located.
2. Release filter from bottom clip, pull down.

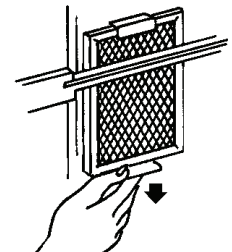
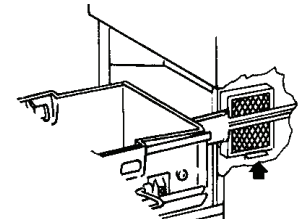

To Replace Filter:

Push replacement filter into place behind top clip. Snap securely into bottom clip.

Special Use Tips

- Your compactor is designed to handle most dry trash. The compactor is not a substitute for a food waste disposer. We urge you to continue to dispose of garbage through a food waste disposer. Most food waste will sour and become odoriferous when held at room temperature.
- Liquid or messy items should be wrapped in newspaper or several thicknesses of paper toweling to help keep the ram and Break-Away basket clean.
- More trash can be compacted if you stop the ram in the "down" position and allow it to dwell there overnight. This will result in heavier bags of compacted trash.
- Place glass bottles on their side in the center for compacting rather than upright. Bottles and cans may nest in lightly compacted paper. When sufficient load is accumulated, most will be crushed. However, due to the resiliency of paper, some bottles may not break. Don't be alarmed by the popping noise made when bottles are crushed. This is normal and will not damage compactor. Placing a newspaper over bottles before compacting will help muffle noise.

WE DO NOT RECOMMEND COMPACTING THESE ITEMS

- Trimnings from cleaning fish or chicken
 - Grapefruit or cantaloupe rinds
 - Paint, oil, gasoline or turpentine cans or rags which have been used with these materials
 - Aerosol cans
 - Insecticide, toxic or caustic containers
 - Wood scraps, rocks, solid metal or large quantities of newspaper.
- These items are already in their compacted form.

WARNING: FIRE/HEALTH HAZARDS

Do not compact containers of flammable or toxic materials or aerosol cans.

Vacation Care

- If you are planning a weekend vacation, you may not want to remove compacted trash if basket is not full. We recommend you simply lock the compactor. On your return, you may wish to run the charcoal air filter for a short time before opening the drawer.
- If you are planning to be away for more than a weekend, we recommend that you remove and discard the compacted trash, replace basket and lock the compactor. Before running a compaction cycle, **always** check that no item has been mistakenly placed in the trash drawer.

Caring for Your Compactor

COMPACTOR INTERIOR

Built-in Small Litter Door and Area:

Wipe clean with a cloth or sponge and a mild detergent or ammonia and water. Rinse with clear water and dry. Do not use abrasive or harsh cleaners.

Break-Away Trash Basket

Clean as necessary after emptying compacted trash. Wearing rubber gloves and using paper towels, remove any small pieces of debris from basket such as crushed glass. **AVOID CONTACT WITH BARE HANDS.** Light soil may be wiped away with a damp sponge or cloth. Heavy soil may require use of mild detergent and water. Rinse with clear water and dry.

Ram

Clean as necessary. Wearing rubber gloves and using paper towels, remove any small pieces of debris from ram, such as paper or crushed glass. **AVOID CONTACT WITH BARE HANDS.** Light soil may be wiped clean with a cloth and mild detergent and water. Heavy soil may require the use of a dampened scouring pad. Rinse with clear water and dry.

Metal Drawer Liner:

Clean as necessary using a cloth or sponge and mild detergent and water. Rinse with clear water and dry. Do not use abrasive cleaners.

Metal Drawer:

Occasionally the drawer latch rod and slide hood located on both sides of the drawer opening should be lubricated. This will prevent the door latch from squeaking or sticking and help insure and extend the life of the latch mechanism. We suggest soap or a solid stick lubricant which can be purchased at auto supply or hardware stores.

Behind Metal Drawer:

Occasionally check the area behind the trash drawer and remove any small pieces of trash. Placing a folded newspaper on top of trash will help prevent small items from sticking to the ram and falling behind the drawer.

NOTE: Drawer may be removed to facilitate the cleaning surrounding areas.

1. Disconnect power supply to compactor before removing drawer.
2. Be sure ram is in "up" position.
3. Open drawer to fully extended position.
4. Remove any drawer retaining screws which hold drawer to track assembly. Carefully remove drawer from track assembly, making sure that the full weight of the drawer is supported at all times.

COMPACTOR EXTERIOR

Front Panels:

Wipe clean with a cloth or sponge and mild detergent and water. Rinse with clear water and wipe dry. Do not use abrasive cleaners. On stainless steel models, use a stainless steel cleaner and polish.

USE ENERGY WISELY

A trash compactor uses a negligible amount of energy. Total energy requirements associated with the trash compactor will be minimized by following the recommendations in the Use and Care Guide.

Service Information

It is assumed that your trash compactor has been properly installed in accordance with all specifications and local codes and that the appliance has been properly grounded. If your trash compactor should fail to operate, check the troubleshooting guide before calling your dealer. You could save the cost of a service call.

If your trash compactor should fail to operate:

- Have you read and followed the instructions provided with this unit?
- Is a fuse blown or the circuit breaker open?
- Is the trash drawer tightly closed? It is possible for a cycle to be incomplete when the drawer has not been firmly closed before turning the key to START. If this occurs, the unit will shut-off, but the drawer cannot be pulled open. Close the drawer firmly and turn the key to START. The ram will return to the original "up" position. Drawer will open only when ram is all the way up.
- Compacting works best when only a few items are loaded. Use the compacting cycle frequently.
- Not all bottles will break every time, depending upon trash load below.

If you are unable to obtain the name of an authorized service agency, or continue to have service problems, call Viking Range Corporation, 1-888-VIKING1 (845-4641), or write to:

**VIKING RANGE CORPORATION
PREFERRED SERVICE
1803 Hwy 82W
Greenwood, Mississippi 38930 USA**

Record the information indicated below. You will need it if service is ever required. The serial and model numbers for your oven are located on an identification plate mounted on the bottom left side of the oven door opening.

Model Number _____ Serial Number _____

Date Purchased _____ Date Installed _____

Dealer's Name _____

Address _____

If service requires installation of parts, use only authorized parts to ensure protection under the warranty.

This manual should remain with the trash compactor for future reference.

**VUC PROFESSIONAL SERIES
UNDERCOUNTER TRASH COMPACTOR WARRANTY**

ONE YEAR FULL WARRANTY

Undercounter trash compactors and all of their component parts, except as detailed below*, are warranted to be free from defective materials or workmanship in normal household use for a period of twelve (12) months from the date of original retail purchase. Viking Range Corporation, warrantor, agrees to repair or replace, at its option, any part which fails or is found to be defective during the warranty period.

*Painted and decorative items are warranted to be free from defective materials or workmanship for a period of ninety (90) days from the date of original retail purchase. ANY DEFECTS MUST BE REPORTED TO THE SELLING DEALER WITHIN NINETY (90) DAYS FROM DATE OF ORIGINAL RETAIL PURCHASE.

FIVE YEAR LIMITED WARRANTY

Any drive system motor which fails due to defective materials or workmanship in normal household use during the second through the fifth year from the date of original retail purchase will be repaired or replaced, free of charge for the part itself, with the owner paying all other costs, including labor.

NINETY (90) DAY RESIDENTIAL PLUS WARRANTY This warranty applies to applications where use of the product extends beyond normal residential use. Examples are, but not limited to, bed and breakfasts, fire stations, private clubs, churches, etc. This warranty excludes all commercial locations such as restaurants, food service locations, and institutional food service locations.

This warranty extends to the original purchaser of the product warranted hereunder and to each transferee owner of the product during the term of the warranty.

This warranty shall apply to products purchased and located in the United States and Canada. Products must be purchased in the country where service is requested. Warranty labor shall be performed by an authorized Viking Range Corporation service agency or representative. Warranty shall not apply to damage resulting from abuse, accident, natural disaster, loss of electrical power to the product for any reason, alteration, outdoor use, improper installation, improper operation or repair or service of the product by anyone other than an authorized Viking Range Corporation service agency or representative. This warranty does not apply to commercial usage. Warrantor is not responsible for consequential or incidental damage whether arising out of breach of warranty, breach of contract, or otherwise. Some jurisdictions do not allow the exclusion of limitation of incidental or consequential damages, so the above limitation or exclusion may not apply to you.

Owner shall be responsible for proper installation, providing normal care and maintenance, providing proof of purchase upon request, and making the appliance reasonably accessible for service. If the product or one of its component parts contains a defect or malfunction during the warranty period, after a reasonable number of attempts by the warrantor to remedy the defects or malfunctions, the owner is entitled to either a refund or replacement of the product or its component part or parts. Replacement of a component part includes its free installation. Warrantor's liability on any claim of any kind, with respect to the goods or services covered hereunder, shall in no case exceed the price of the goods or service or part thereof which give rise to the claim.

WARRANTY SERVICE: Under the terms of this warranty, service must be performed by a factory authorized Viking Range Corporation service agent or representative. Service will be provided during normal business hours, and labor performed at overtime or premium rates shall not be covered by this warranty. To obtain warranty service, contact the dealer from whom the product was purchased, an authorized Viking Range Corporation service agent, or Viking Range Corporation. Provide model and serial number and date of original retail purchase. For the name of your nearest authorized Viking Range Corporation service agency, call the dealer from whom the product was purchased or Viking Range Corporation. **IMPORTANT:** Retain proof of original purchase to establish warranty period.

The return of the Owner Registration Card is not a condition of warranty coverage. You, however, should return the Owner Registration Card so that Viking Range Corporation can contact you should any question of safety arise which could affect you.

Any implied warranties of merchantability and fitness applicable to the above described drive system motor is limited in duration to the period of coverage of the applicable express written limited warranties set forth above. Some jurisdictions do not allow limitations on how long an implied warranty lasts, so the above limitation may not apply to you. This warranty gives you specific legal rights, and you may also have other rights which may vary from jurisdiction to jurisdiction.

Specifications subject to change without notice.

